

SONY®

4-081-775-22



FD Trinitron
WEGA™

Operating Instructions

KV-32FV27 KV-36FV27

WARNING

To reduce the risk of fire or shock hazard, do not expose the TV to rain or moisture.

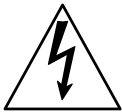
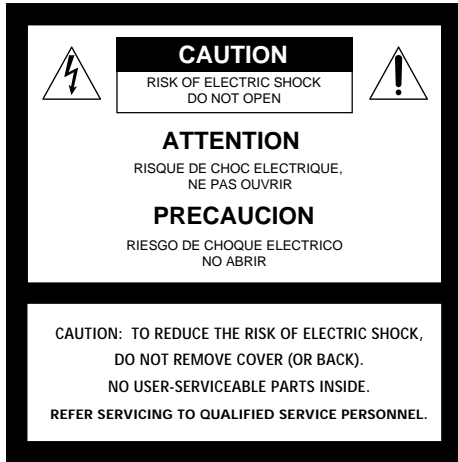

This symbol is intended to alert the user to the presence of uninsulated “dangerous voltage” within the product’s enclosure that may be of sufficient magnitude to constitute a risk of electric shock to persons.



This symbol is intended to alert the user to the presence of important operating and maintenance (servicing) instructions in the literature accompanying the appliance.

CAUTION

TO PREVENT ELECTRIC SHOCK, MATCH WIDE BLADE OF PLUG TO WIDE SLOT, FULLY INSERT.

CAUTION

When using TV games, computers, and similar products with your TV, keep the brightness and contrast functions at low settings. If a fixed (non-moving) pattern is left on the screen for long periods of time at a high brightness or contrast setting, the image can be permanently imprinted onto the screen. Continuously watching the same program can cause the imprint of station logos onto the TV screen. These types of imprints are not covered by your warranty because they are the result of misuse.

Note on Caption Vision

This television receiver provides display of television closed captioning in accordance with §15.119 of the FCC rules.

Note on Cleaning the TV

Clean the TV with a soft dry cloth. Never use strong solvents such as thinner or benzine, which might damage the finish of the cabinet.

Note to CATV System Installer

This reminder is provided to call the CATV system installer’s attention to Article 820-40 of the NEC that provides guidelines for proper grounding and, in particular, specifies that the cable ground shall be connected to the grounding system of the building, as close to the point of cable entry as practical.

Use of this television receiver for other than private viewing of programs broadcast on UHF or VHF or transmitted by cable companies for the use of the general public may require authorization from the broadcaster/cable company and/or program owner.

NOTIFICATION

This equipment has been tested and found to comply with the limits for a Class B digital device pursuant to Part 15 of the FCC Rules. These limits are designed to provide reasonable protection against harmful interference in a residential installation. This equipment generates, uses, and can radiate radio frequency energy and, if not installed and used in accordance with the instructions, may cause harmful interference with radio communications. However, there is no guarantee that interference will not occur in a particular installation. If this equipment does cause harmful interference to radio or television reception, which can be determined by turning the equipment off and on, the user is encouraged to try to correct the interference by one or more of the following measures:

- Reorient or relocate the receiving antennas.
 - Increase the separation between the equipment and receiver.
 - Connect the equipment into an outlet on a circuit different from that to which the receiver is connected.
 - Consult the dealer or an experienced radio/TV technician for help.
- You are cautioned that any changes or modifications not expressly approved in this manual could void your authority to operate this equipment.

Safety

- Operate the TV only on 120 V AC.
- The plug is designed, for safety purposes, to fit into the wall outlet only one way. If you are unable to insert the plug fully into the outlet, contact your dealer.
- If any liquid or solid object should fall inside the cabinet, unplug the TV immediately and have it checked by qualified service personnel before operating it further.

Installing

- To prevent internal heat buildup, do not block the ventilation openings.
- Do not install the TV in a hot or humid place, or in a place subject to excessive dust or mechanical vibration.
- The AC power cord is attached to the rear of the TV with hooks. Do not attempt to remove the cord from these hooks. Doing so could cause damage to the TV

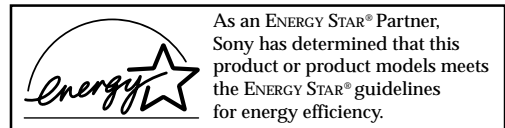

ENERGY STAR® is a U.S. registered mark.

SRS™ The SRS (●) (SOUND RETRIEVAL SYSTEM) is manufactured by Sony Corporation under license from SRS Labs, Inc. It is covered by U.S. Patent No. 4,748,669. Other U.S. and foreign patents pending. The word “SRS” and the SRS symbol (●) are registered trademarks of SRS Labs, Inc.

Licensed by BBE Sound, Inc. under USP 4638258.4482866. BBE and BBE symbol are trademarks of BBE Sound, Inc.

FD Trinitron and the Wega logo are trademarks of Sony Corporation.

Owner’s Record

The model and serial numbers are provided on the front of this instruction manual and at the rear of the TV. Refer to them whenever you call upon your Sony dealer regarding this product.

About this Manual

This manual is for models KV-32FV27 and KV-36FV27. The menu and illustrations shown are for model KV-36FV27 to show the maximum features available. Differences in operation will be indicated in the text, for example, “For KV-36FV27 only.”

Important Safeguards

For your protection, please read these instructions completely, and keep this manual for future reference.

Carefully observe and comply with all warnings, cautions and instructions placed on the set or described in the operating instructions or service manual.

WARNING

To guard against injury, the following basic safety precautions should be observed in the installation, use and servicing of the set.

Use

Power Sources

This set should be operated only from the type of power source indicated on the serial/model plate. If you are not sure of the type of electrical power supplied to your home, consult your dealer or local power company. For those sets designed to operate from battery power, refer to the operating instructions.



Grounding or Polarization

This set is equipped with a polarized AC power cord plug (a plug having one blade wider than the other), or with a three-wire grounding type plug (a plug having a third pin for grounding). Follow the instructions below:

For the set with a polarized AC power cord plug

This plug will fit into the power outlet only one way. This is a safety feature. If you are unable to insert the plug fully into the outlet, try reversing the plug. If the plug still fails to fit, contact your electrician to have a suitable outlet installed. Do not defeat the safety purpose of the polarized plug by forcing it in.



Alternate Warning

For the set with a three-wire grounding type AC plug

This plug will only fit into a grounding-type power outlet. This is a safety feature. If you are unable to insert the plug into the outlet, contact your electrician to have a suitable outlet installed. Do not defeat the safety purpose of the grounding plug.

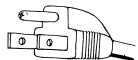

Overloading

Do not overload wall outlets, extension cords or convenience receptacles beyond their capacity, since this can result in fire or electric shock.

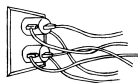

Always turn the set off when it is not being used. When the set is left unattended and unused for long periods of time, unplug it from the wall outlet as a precaution against the possibility of an internal malfunction that could create a fire hazard.



If a snapping or popping sound from a TV set is continuous or frequent while the TV is operating, unplug the TV and consult your dealer or service technician. It is normal for some TV sets to make occasional snapping or popping sounds, particularly when being turned on or off.

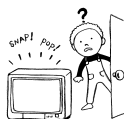

Object and Liquid Entry

Never push objects of any kind into the set through the cabinet slots as they may touch dangerous voltage points or short out parts that could result in a fire or electric shock. Never spill liquid of any kind on the set.



Cleaning

Unplug the set from the wall outlet before cleaning or polishing it. Do not use liquid cleaners or aerosol cleaners. Use a cloth lightly dampened with water for cleaning the exterior of the set.



Installation

Attachments

Do not use attachments not recommended by the manufacturer, as they may cause hazards.



Water and Moisture

Do not use power-line operated sets near water — for example, near a bathtub, washbowl, kitchen sink, or laundry tub, in a wet basement, or near a swimming pool, etc.



Accessories

Do not place the set on an unstable cart, stand, table or shelf. The set may fall, causing serious injury to a child or an adult and serious damage to the set. Use only a cart or stand recommended by the manufacturer for the specific model of TV. An appliance and cart combination should be moved with care. Quick stops, excessive force, and uneven surfaces may cause the appliance and cart combination to overturn.



Ventilation

The slots and openings in the cabinet and in the back or bottom are provided for necessary ventilation. To ensure reliable operation of the set, and to protect it from overheating, these slots and openings must never be blocked or covered.

- Never cover the slots and openings with a cloth or other materials.
- Never block the slots and openings by placing the set on a bed, sofa, rug or other similar surface.
- Never place the set in a confined space, such as a bookcase or built-in cabinet, unless proper ventilation is provided.
- Do not place the set near or over a radiator or heat register, or where it is exposed to direct sunlight.



Power-Cord Protection

Do not allow anything to rest on or roll over the power cord, and do not place the set where the power cord is subject to wear or abuse.



Antennas

Outdoor Antenna Grounding

If an outdoor antenna is installed, follow the precautions below. An outdoor antenna system should not be located in the vicinity of overhead power lines or other electric light or power circuits, or where it can come in contact with such power lines or circuits.

WHEN INSTALLING AN OUTDOOR ANTENNA SYSTEM, EXTREME CARE SHOULD BE TAKEN TO KEEP FROM CONTACTING SUCH POWER LINES OR CIRCUITS AS CONTACT WITH THEM IS ALMOST INVARIABLY FATAL.

Be sure the antenna system is grounded so as to provide some protection against voltage surges and built-up static charges. Section 810 of the National Electrical Code (NEC) in USA and Section 54 of the Canadian Electrical Code in Canada provides information with respect to proper grounding of the mast and supporting structure, grounding of the lead-in wire to an antenna discharge unit, size of grounding conductors, location of antenna discharge unit, connection to grounding electrodes, and requirements for the grounding electrode.

Antenna Grounding According to the NEC

Refer to section 54-300 of Canadian Electrical Code for Antenna Grounding.

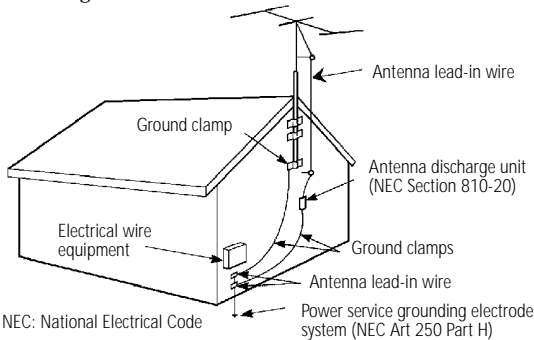

Lightning

For added protection for this television receiver during a lightning storm, or when it is left unattended and unused for long periods of time, unplug it from the wall outlet and disconnect the antenna. This will prevent damage to the receiver due to lightning and power-line surges.

Service

Damage Requiring Service

Unplug the set from the wall outlet and refer servicing to qualified service personnel under the following conditions:

- When the power cord or plug is damaged or frayed.
- If liquid has been spilled into the set.
- If the set has been exposed to rain or water.
- If the set has been subject to excessive shock by being dropped, or the cabinet has been damaged.
- If the set does not operate normally when following the operating instructions. Adjust only those controls that are specified in the operating instructions. Improper adjustment of other controls may result in damage and will often require extensive work by a qualified technician to restore the set to normal operation.
- When the set exhibits a distinct change in performance, it indicates a need for service.

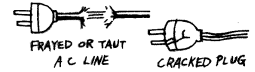

Servicing

Do not attempt to service the set yourself since opening the cabinet may expose you to dangerous voltage or other hazards. Refer all servicing to qualified service personnel.



Replacement Parts

When replacement parts are required, be sure the service technician certifies in writing that he has used replacement parts specified by the manufacturer that have the same characteristics as the original parts.

Unauthorized substitutions may result in fire, electric shock or other hazards.

Safety Check

Upon completion of any service or repairs to the set, ask the service technician to perform routine safety checks (as specified by the manufacturer) to determine that the set is in safe operating condition, and to so certify. When the set reaches the end of its useful life, improper disposal could result in a picture tube implosion. Ask a qualified service technician to dispose of the set.



Contents

Introducing the FD Trinitron Wega

Overview	1
Presenting the FD Trinitron Wega.....	2
Package Contents	3
Using the Remote Control	3

Installing the TV

Overview	7
TV Controls and Connectors	8
Basic Connections (Connecting a Cable or Antenna)	10
Connecting a VCR and Cable.....	14
Connecting a VCR and Cable Box	15
Connecting Two VCRs for Tape Editing	18
Connecting a Satellite Receiver	19
Connecting a Satellite Receiver with a VCR ...	20
Connecting an Audio Receiver	22
Connecting a DVD Player with Component Video Connectors.....	23
Connecting a DVD Player with A/V Connectors	24
Connecting a Camcorder	25
Using the CONTROL S Feature	26
Setting Up the TV Automatically	27

Using the Features

Overview	29
Using Favorite Channels.....	30
Using Picture in Picture (PIP)	31
Using Wireless Headphones	34

Using the Menus

Overview	37
Using the Video Menu	38
Using the Audio Menu	40
Using the Channel Menu.....	42
Using the Parent Menu	44
Using the Timer Menu	47
Using the Setup Menu.....	48
Using the Basic Menu.....	50

Other Information

Overview	51
Programming the Remote Control	52
Operating Other Components with Your TV Remote Control	54
Troubleshooting.....	56
Specifications	58
Index	61

Introducing the FD Trinitron Wega

Overview

This chapter defines the contents of your Wega TV and provides an overview of how to set up and use basic features.

<i>Topic</i>	<i>Page</i>
Presenting the FD Trinitron Wega	2
Package Contents	3
Using the Remote Control	3

Presenting the FD Trinitron Wega

The FD Trinitron Wega (pronounced VAY-GAH) is characterized by outstanding contrast, uncompromising accuracy, and corner-to-corner detail.

You'll recognize the superiority of Wega technology almost immediately. The first thing you probably will notice is minimal glare from the flat picture tube. This flat-screen technology improves picture detail without distortion, unlike conventional curved screens. The FD Trinitron delivers outstanding image detail not only at the screen center, but also at the corners — so you can enjoy a bright, clear picture from any location in a room.

Features

Some of the features that you will enjoy with your new TV include:

- ❑ **16:9 Enhancement:** Vertical Compression technology that maximizes picture resolution on “anamorphic” or “enhanced for widescreen” sources, including selected DVDs.
- ❑ **Velocity Modulation:** Vertical line enhancement that sharpens picture definition.
- ❑ **Steady Sound:** Equalizes volume levels so there is consistent output between programs and commercials.
- ❑ **Parental Control:** V-Chip technology allows parents to block unsuitable programming for younger viewers.
- ❑ **Component Video Inputs:** Offers the best video quality for DVD player connections.
- ❑ **S-VIDEO Inputs:** Provides a high-quality image for connected equipment.
- ❑ **Dual Tuner Picture in Picture (PIP):** Allows you to watch two programs at once.
- ❑ **Favorite Channel Preview:** Preview up to eight favorite channels without leaving the current channel.
- ❑ **Wireless Infrared Headphones:** Enjoy listening to programs without disturbing anyone else.

Package Contents

Along with your new Trinitron TV, the packing box contains a remote control, a pair of wireless headphones, and three AA batteries (two for the remote control, one for the headphones). These items are all you need to set it up and operate the TV in its basic configuration.

Most peripherals come with the necessary cables to connect them. If you want to set up special configurations, you may need to buy extra cables or connectors. It is best to ensure that you have all needed materials on hand before beginning a special-connection project.

Using the Remote Control

The remote control is the primary mechanism for controlling your TV. Handle the remote control with care; avoid dropping it, getting it wet, placing it in direct sunlight, near a heater, or where the humidity is high.

Inserting Batteries

Insert two size AA (R6) batteries (supplied) by matching the + and – on the batteries to the diagram inside the battery compartment.

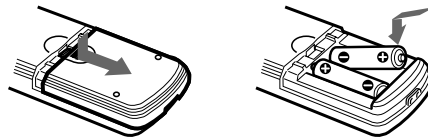

 Remove the batteries to avoid damage from possible battery leakage whenever you anticipate that the remote control will not be used for an extended period.

Button Descriptions



The POWER button on the remote control (no. 13 in the illustration below) activates both the remote control and the TV.

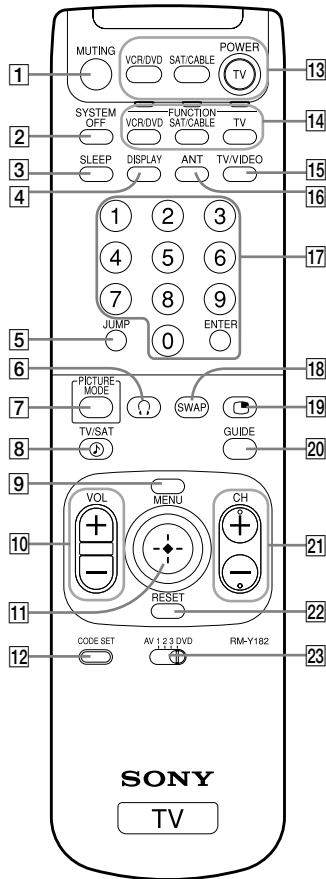

Outside Panel



RM-Y182





 To scan rapidly through the channels, press and hold down the CH+ or CH- button.

Button	Description
1 MUTING	Press to mute the sound. Press again or press VOL + to restore the sound.
2 SYSTEM OFF	Powers off all Sony equipment at once. (This feature may not work with older Sony equipment.)
3 SLEEP	Press repeatedly until the TV displays the time in minutes (15, 30, 45, 60, or 90) that you want the TV to remain on before shutting off automatically. Cancel by pressing until SLEEP OFF appears. While Sleep feature is set, press once to view remaining time
4 DISPLAY	Press once to display the current time and channel label (if set) and channel number. Press again to turn Display off. See page 47 for details on setting the time.
5 JUMP	Press to jump back and forth between two channels. The TV alternates between the current channel and the last channel that was selected.
6 	Turns the headphones on/off.
7 PICTURE MODE	Press repeatedly to step through the available video picture modes: Vivid, Standard, Movie, Sports. Also available in the Video menu. For details, see "Selecting Video Options" on page 38.
8 TV/SAT	Switches between the TV and SAT (satellite) inputs when in SAT FUNCTION mode. Provides quick access for changing available audio settings. For details, see "Using the Audio Menu" on page 40.
9 MENU	Press to display the TV on-screen menu. Press again to exit from the menus.
10 VOL +/-	Adjusts the volume.
11 	Joystick allows for movement of the on-screen cursor. Pressing down on the center of the joystick selects the item.
12 CODE SET	Used for programming the remote control to operate non-Sony video equipment. For details, see "Programming the Remote Control" on page 52.
13 POWER buttons (GREEN)	Turn on and off the TV and other audio/video equipment you have programmed into the remote control. For instructions, see "Programming the Remote Control" on page 52.
14 FUNCTION buttons	Select the equipment (TV, VCR/DVD, SAT/CABLE) that you want to operate. The indicator lights up momentarily when pushed to show which device the remote control is operating.

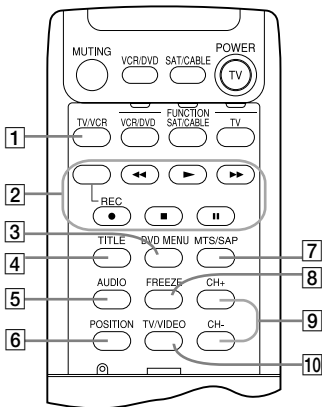
Button	Description
15 TV/VIDEO	Cycles through the video equipment connected to the TV's video inputs: TV, VIDEO 1, VIDEO 2, VIDEO 3, VIDEO 4.
16 ANT	Changes between the VHF/UHF input to the AUX input.
17 0 – 9 and ENTER	Press 0 - 9 to select a channel, the channel changes after 2 seconds. Press ENTER to select immediately.
18 SWAP	Switches the position of the main picture with the window picture.
19 	Turns on/off PIP. For details, see "Using Picture in Picture (PIP)" on page 31.
20 GUIDE	Displays the program guide of your satellite antenna.
21 CH +/-	Scan through channels.
22 RESET	Press when in a menu to reset the settings to the factory defaults.
23  AV 1 2 3 DVD	Use to switch control for connected video equipment. You can program one video source for each switch position. For details, see "Programming the Remote Control" on page 52.

Inside Panel



1 TV/VCR	Switch between TV and VCR mode. If you have a non-Sony VCR, you will need to program the remote control to recognize your VCR. For details, see "Programming the Remote Control" on page 52.
2  REC	Rewind
	Fast-forward
	Play
	Stop
	Pause (Press again to resume normal playback)
3 DVD MENU	Displays the DVD's menu.
4 TITLE	Displays the DVD's Title menu.
5 AUDIO	Alternates sound between the main picture and the window picture.
6 POSITION	Moves the location of the PIP window picture.
7 MTS/SAP	Cycles through the Multi-channel TV Sound (MTS) options: Stereo, Auto-SAP, Mono.
8 FREEZE	Freezes the window picture. Press again to restore the picture.
9 CH +/-	Changes the channel in the PIP window picture.
10 TV/VIDEO	The PIP window picture, cycles through the video equipment connected to your TV's video inputs: TV, VIDEO 1, VIDEO 2, VIDEO 3, VIDEO 4. This allows you to select different sources for the PIP display.

Installing the TV

Overview

This chapter includes illustrated instructions for setting up your TV.

<i>Topic</i>	<i>Page</i>
TV Controls and Connectors	8
Basic Connections (Connecting a Cable or Antenna)	10
Connecting a VCR and Cable	14
Connecting a VCR and Cable Box	15
Connecting Two VCRs for Tape Editing	18
Connecting a Satellite Receiver	19
Connecting a Satellite Receiver with a VCR	20
Connecting an Audio Receiver	22
Connecting a DVD Player with Component Video Connectors	23
Connecting a DVD Player with A/V Connectors	24
Connecting a Camcorder	25
Using the CONTROL S Feature	26
Setting Up the TV Automatically	27

Note About the AC Power Cord

The AC power cord is attached to the rear of the TV with hooks. Use caution when removing the AC plug from its holder. Gently slide the cord in the upward direction without removing the cord from the two lower hooks.

You can detach the cord from this hook

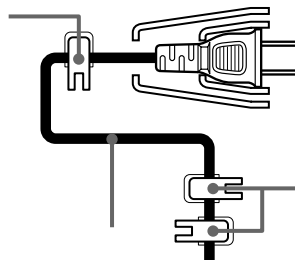

Do not remove the cord from the hooks.

AC Power cord

TV Controls and Connectors

Front Panel Menu Controls

The front panel menu controls allow access to the on-screen menus without the use of a remote control. Pressing the MENU button brings up the on-screen menus. The arrow buttons (↕) move the on-screen cursor in the menus and the (⊕) button selects the menu item.

TV Rear Panel

Model KV-36FV27

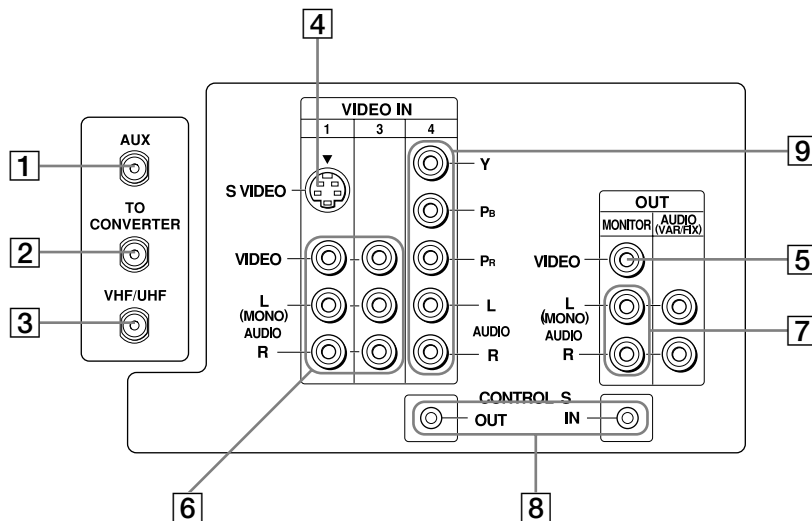

Back Panel Descriptions

Connection	Description
1 AUX	Allows you to view local and cable channels if your cable provider does not feature local channels. You can switch between local and cable channels easily by pressing ANT on the remote control. Devices connected to the AUX input cannot be viewed in PIP.
2 TO CONVERTER	This is a VHF/UHF out jack that lets you set up your TV to switch between scrambled channels (through a cable box) and normal cable channels (CATV). Use this jack instead of a splitter to get better picture quality when needing to switch between scrambled and unscrambled cable channels.
3 VHF/UHF	Connects to your VHF/UHF antenna or cable.

<i>Connection</i>	<i>Description</i>
4 S VIDEO	Connects to the S VIDEO OUT jack of your VCR or other S VIDEO-equipped video component. Provides better picture quality than the VHF/UHF jacks or the Video IN jack.
5 MONITOR OUT	Lets you record the program you are watching to a VCR. When two VCRs are connected (see page 18), you can use your TV as a monitor for tape-to-tape editing.
6 AUDIO (L/R)/ VIDEO	Connects to the audio and video OUT jacks on your VCR or other video component. A third video input (VIDEO 2) is located on the front panel of the TV. The Audio and Video IN jacks provide better picture quality than the VHF/UHF jack.
7 AUDIO OUT (VAR/FIX) L (MONO)/R	Connects to the left and right audio inputs of your audio or video component. You can use these outputs to listen to your TV's audio through your stereo system.
8 CONTROL S IN/OUT	Allows the TV to receive (IN) and send (OUT) remote control signals (via wire) to other Sony infrared-controlled audio or video components.
9 Y, PB, PR, L, R	Connects to your DVD player's or Digital Set-top box's component video (Y, PB, PR) and audio (L/R) jacks.

Basic Connections (Connecting a Cable or Antenna)

Connecting Directly to Cable or to an Antenna

The connection you choose depends on the cable found in your home.

Newer homes usually have standard coaxial cable:

VHF Only or VHF/UHF or Cable

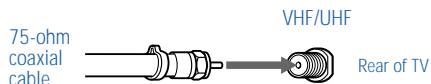

Older homes may have 300-ohm, twin-lead cable:

VHF Only or UHF Only or VHF/UHF

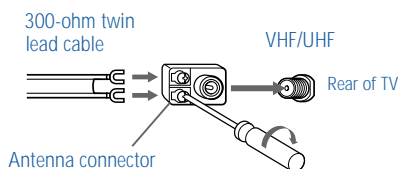

Other homes may have both:

VHF and UHF

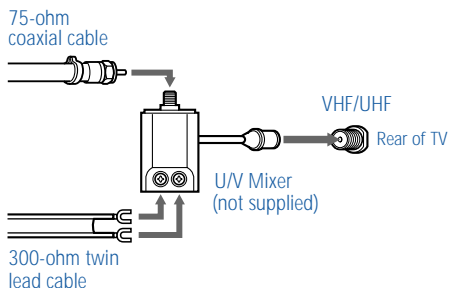

Cable and Antenna

If your cable provider does not feature local channels, you may find this set-up convenient.

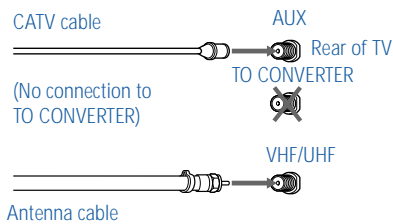

To receive channels using an antenna, instead of using the CATV cable

- 1 Select antenna mode by pressing the ANT button on the remote control. (This is a toggle: pressing the button once selects antenna mode; pressing the button again selects cable mode.)
- 2 Turn the Cable to OFF (see page 42).
- 3 Perform the Auto Program function (see page 42).

Basic Cable Box Connections

Cable Box and Cable

This is the preferred basic cable TV hookup to use if your cable TV company scrambles some channels, but not all of them (pay channels vs. regular cable channels), and you need to use a cable box.

With this setup you can:

- Use the TV remote control to change channels on your cable box when the signal is scrambled.
- Use the TV remote control to change channels using your TV when the signal is not scrambled. (Your TV's tuner provides a better signal than the cable box.)
- Use the PIP feature normally with the CATV input.
- Use the PIP feature partially with the cable box. (When you switch the TV input to AUX — to use the cable box — the scrambled picture will display only in the main window. If you turn on the PIP, you will be able to see any of the regular channels in the PIP window, but you cannot SWAP the pictures between the main and PIP windows.)

(Continued from the previous page)

- 1 Connect the Cable TV cable to the TV's VHF/UHF jack.
- 2 Using a coaxial cable, connect the TV's TO CONVERTER jack to the cable box's IN jack. The TV's internal converter allows you to switch between unscrambled signals coming straight into the TV and scrambled signals coming in through the cable box, eliminating the need for an external splitter.
- 3 Using a coaxial cable, connect the cable box's OUT jack to the TV's AUX jack.

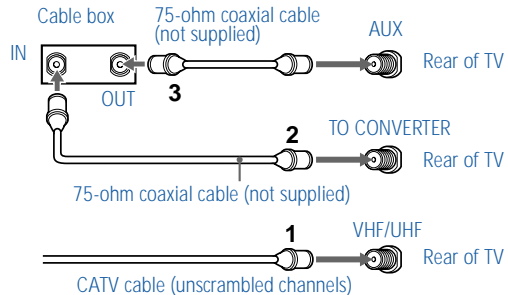

To switch between channels from cable box and channels from regular cable

- ❑ Press the ANT button on the TV remote control. (This is a toggle: pressing the button once selects the cable box; pressing the button again selects regular cable.)

To use the cable box

- ❑ Have your TV tuner set to channel 3 or 4 (as appropriate) and then use the cable box to switch channels.

To use the TV remote control to switch channels on the cable box

- ❑ Program the remote control as necessary. (See “Programming the Remote Control” on page 52.) Then use the remote control to switch cable box channels.

To use the TV remote control to switch channels on the VCR

- ❑ Program the remote control as necessary. (By default, the remote control is set for a Sony VCR; to change to another brand see “Programming the Remote Control” on page 52.) Then use the VCR buttons on the remote control to switch channels on the VCR.

To prevent the accidental switching of TV channels

- ❑ When using the cable box, you need your TV to stay on a required channel (usually channel 3 or 4). You can use the TV's Channel Fix feature to lock in a specific channel. The Channel Fix feature is under the Channel menu. For details, see “Using the Channel Menu” on page 42.

Cable Box only

Use this hookup if:

- ❑ You subscribe to a cable TV system that scrambles or encodes all signals, requiring a cable box to view all channels, and
- ❑ You do not intend to hook up any other audio or video equipment to your TV.

When all channels are routed through your cable box, only one unscrambled signal is sent to the TV, so you cannot use the PIP feature. If some of your channels are scrambled, but others are not, consider using the hookup “Cable Box and Cable” on page 11 instead.

- 1 Connect the coaxial connector from your cable service to the cable box’s IN jack.
- 2 Using a coaxial cable, connect the cable box’s OUT jack to the TV’s VHF/UHF jack.

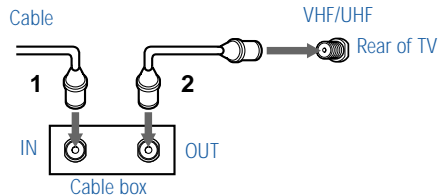

Connecting a VCR and Cable

Use this hookup if you subscribe to a cable TV (CATV) system that does not require a cable box.

- 1 Connect the CATV cable to the VCR's IN jack.
- 2 Using a coaxial cable, connect the VCR's OUT jack to the TV's VHF/UHF jack.
- 3 Using an A/V cable, connect the VCR's Audio and Video OUT jacks to the TV's Audio and Video IN jacks.

 If the VCR you are connecting has an S VIDEO jack, you can use an S VIDEO cable for improved picture quality (compared to a combination audio/video cable). Because S VIDEO cables carry only the video signal, you will need audio cables for sound.

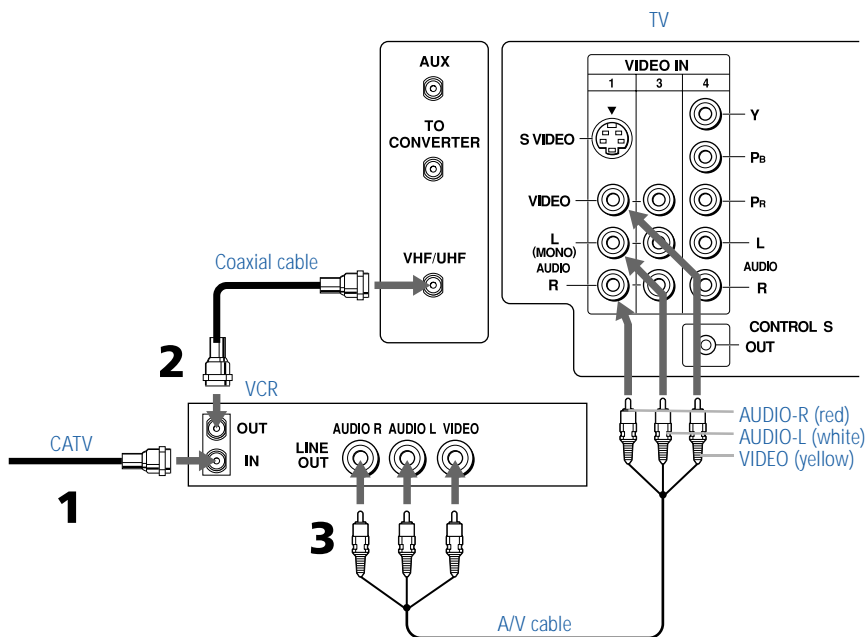

Connecting a VCR and Cable Box

Use this hookup if:

- ❑ Your cable TV company scrambles some channels, but not all of them (pay channels vs. regular cable channels) and you therefore need to use a cable box, and
- ❑ You want to use the PIP feature.

With this setup you can:

- ❑ Use the TV remote control to change cable box channels when the signal is scrambled.
- ❑ Use the TV remote control to change TV channels when the signal is not scrambled. (Your TV's tuner provides a better signal than the cable box.)
- ❑ Use the PIP feature.
- ❑ Record both regular CATV and scrambled channels.

To connect a cable box and a VCR, you will need:

- ❑ A small, inexpensive device known as a splitter.
 - ❑ Three coaxial cables.
 - ❑ Either a combination audio/video cable, or an S VIDEO cable and audio cables.
- 1 Connect the CATV cable to the single (input) jack of the splitter.
 - 2 Use a coaxial cable to connect one of the two output jacks of the splitter to the TV's VHF/UHF jack.
 - 3 Use a coaxial cable to connect the other output jack of the splitter to the input jack of the cable box.
 - 4 Use a coaxial cable to connect the output jack of the cable box to the input jack of the VCR.
 - 5 Use the video line (yellow) of a combination audio/video (A/V) cable to connect the video output jack of the VCR to the video input jack of the TV.

 If the VCR has an S VIDEO jack, you can use an S VIDEO cable to improve picture quality; replace the yellow video cable of the combination A/V cable with the S VIDEO cable. You will still need audio cables for sound.

Connect the left (white) and right (red) audio output channels of the VCR to the respective input channels on the TV.

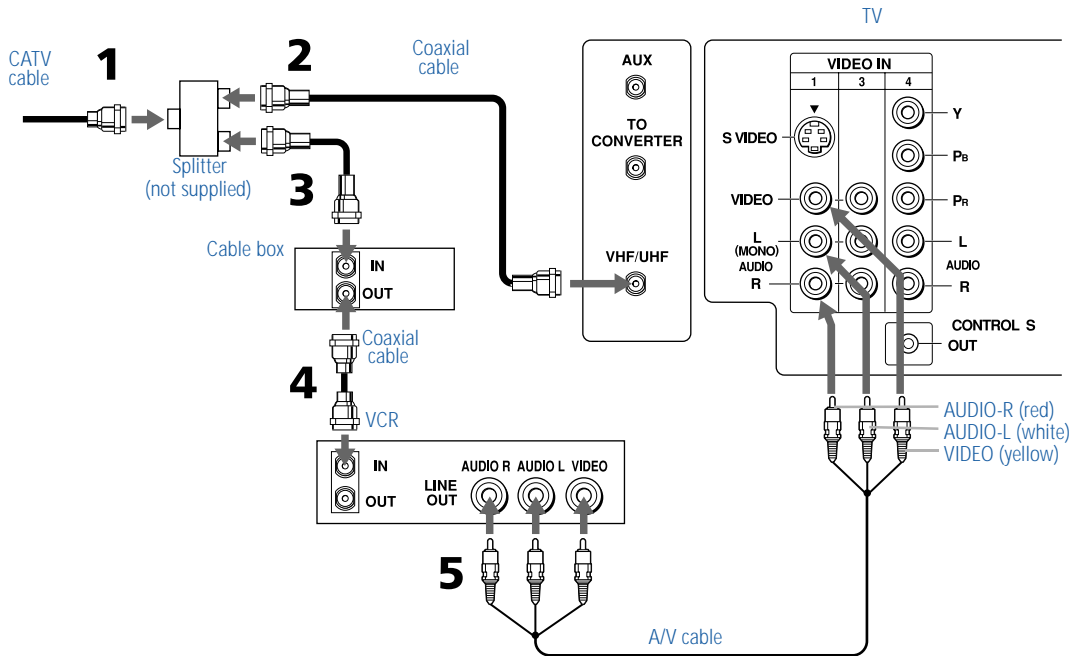

To view cable box channels

- ❑ Turn on the VCR and set it to the channel the cable box uses (channel 3 or 4). Set the TV to VIDEO 1. Use the cable box to switch channels.

To use the TV remote control to switch channels on the cable box

- ❑ Program the remote control as necessary. (See “Programming the Remote Control” on page 52.) Then use the remote control to switch cable box channels.

To use the TV remote control to switch channels on the VCR

- ❑ Program the remote control as necessary. (By default, the remote control is set for a Sony VCR; to change to another brand see “Programming the Remote Control” on page 52.) Then use the VCR buttons on the remote control to switch VCR channels.

To use PIP with the Cable Box

- ❑ **Turn on the cable box and VCR. Use the remote control's TV/VIDEO (yellow) button to set the PIP output to VIDEO 1. Change the PIP channel via the cable box. (The cable box's tuner is used as the PIP video source; if you do not turn on the cable box, the PIP will not work.)**

 This system is needed because the cable box unscrambles only one channel at a time (unlike regular cable, which makes all channels available concurrently).

Connecting Two VCRs for Tape Editing

If you connect two VCR's together, so you can record from one to the other, you may want to monitor the recording process. You can connect the recording VCR into your TV and then view what is being recorded. The procedure below shows you how to do this.

- 1 Using an A/V cable, connect the playback VCR's Audio and Video OUT jacks to the recording VCR's Audio and Video IN jacks.
- 2 Using an A/V cable, connect the recording VCR's Audio and Video OUT jacks to the TV's Audio and Video IN jacks.

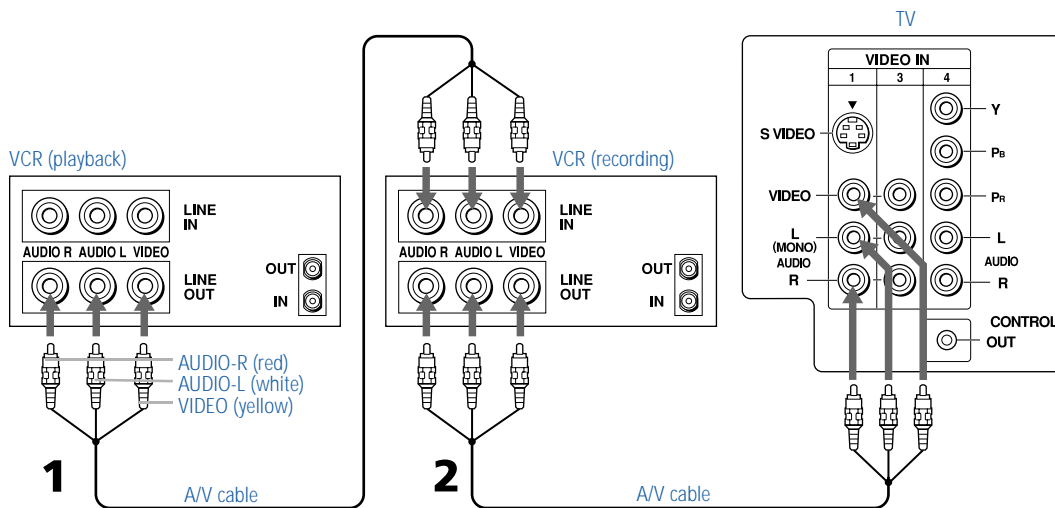

To change the video input of the VCR.

- See your VCR's user's guide for instructions.

To view what is being recorded

- Use the remote control to set the TV to the video input that the recording VCR is connected to. (VIDEO 1 in the illustration above.)

 If the VCRs you are connecting have S VIDEO jacks, you can use S VIDEO cables to improve picture quality; replace the yellow video cable of the combination A/V cable with the S VIDEO cable. You will still need audio cables for sound.

Connecting a Satellite Receiver

- 1 Connect the satellite antenna cable to the satellite receiver's SATELLITE IN jack.
- 2 Using an A/V cable, connect the satellite receiver's Audio and Video OUT jacks to the TV's Audio and Video IN jacks.
- 3 Connect a coaxial cable from your cable or antenna to the TV's VHF/UHF jack.

 If the satellite receiver has an S VIDEO jack, you can use an S VIDEO cable to improve picture quality; replace the yellow video cable of the combination A/V cable with the S VIDEO cable. You will still need audio cables for sound.

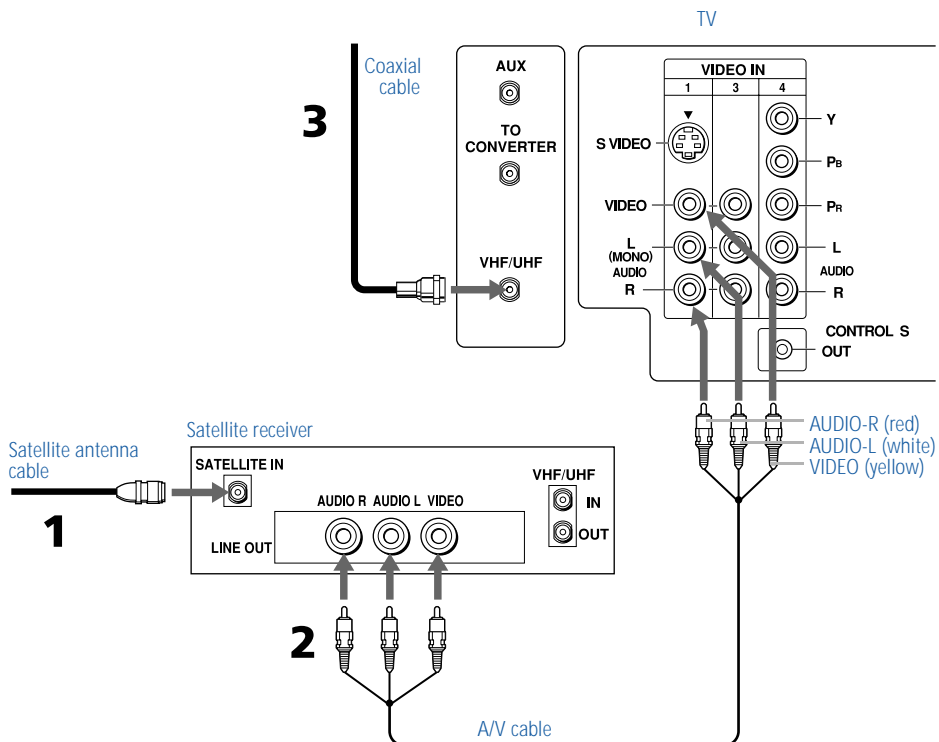

Connecting a Satellite Receiver with a VCR

- 1 Connect the satellite antenna cable to the satellite receiver's SATELLITE IN jack.
- 2 Connect the CATV cable to the VCR's VHF/UHF IN jack.
- 3 Using a coaxial cable, connect the VCR's OUT jack to the TV's VHF/UHF jack.
- 4 Using an A/V cable, connect the satellite receiver's Audio and Video OUT jacks to the VCR's Audio and Video IN jacks.
- 5 Using an A/V cable, connect the VCR's Audio and Video OUT jacks to the TV's Audio and Video IN jacks.

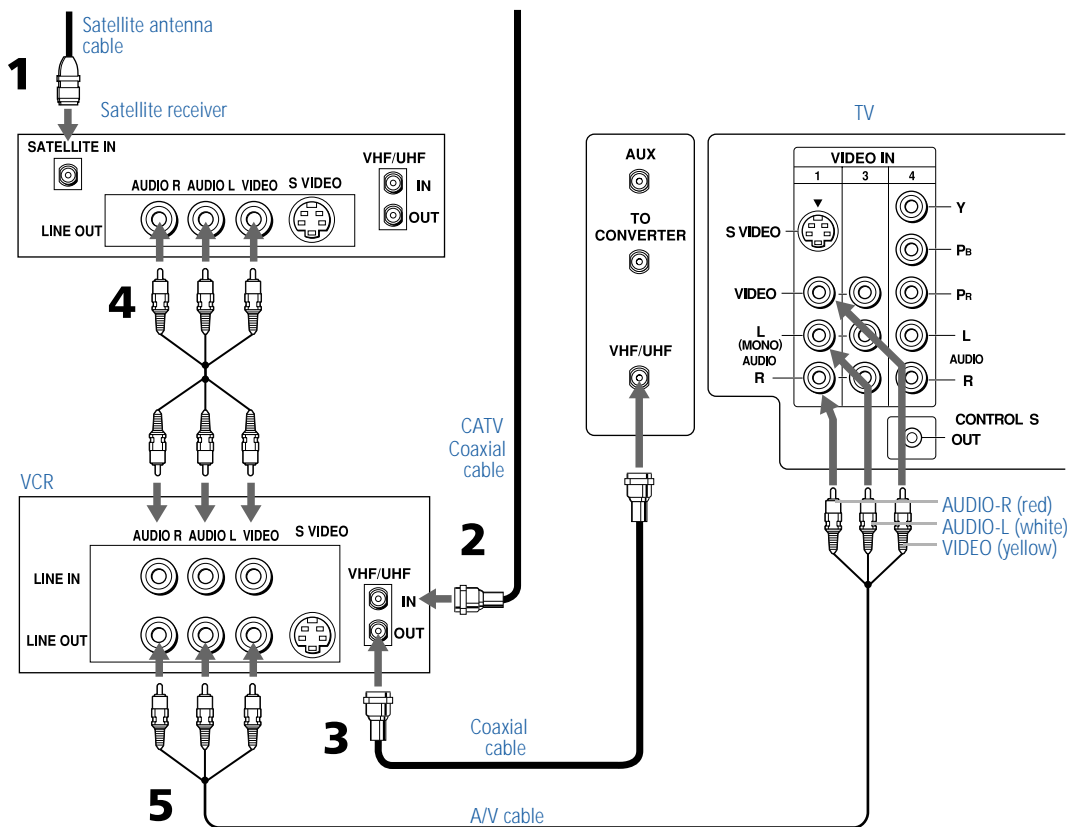

 If the satellite receiver and VCR have S VIDEO jacks, you can use an S VIDEO cable to improve picture quality; replace the yellow video cable of each combination A/V cable with the S VIDEO cable. You will still need audio cables for sound.

To change VCR video input

- ❑ See your VCR's user's guide for instructions.

To watch satellite TV, or the VCR

- ❑ Use the TV/VIDEO on the remote control to select video source.

To watch cable TV

- ❑ Use the TV/VIDEO on the remote control to select VHF/UHF source.

Connecting an Audio Receiver

For improved sound quality, you may want to send the TV's audio signals to your stereo system. The procedure below tells you how.

- 1 Using audio cables, connect the TV's Audio OUT jacks to the audio receiver's Audio LINE IN jacks.

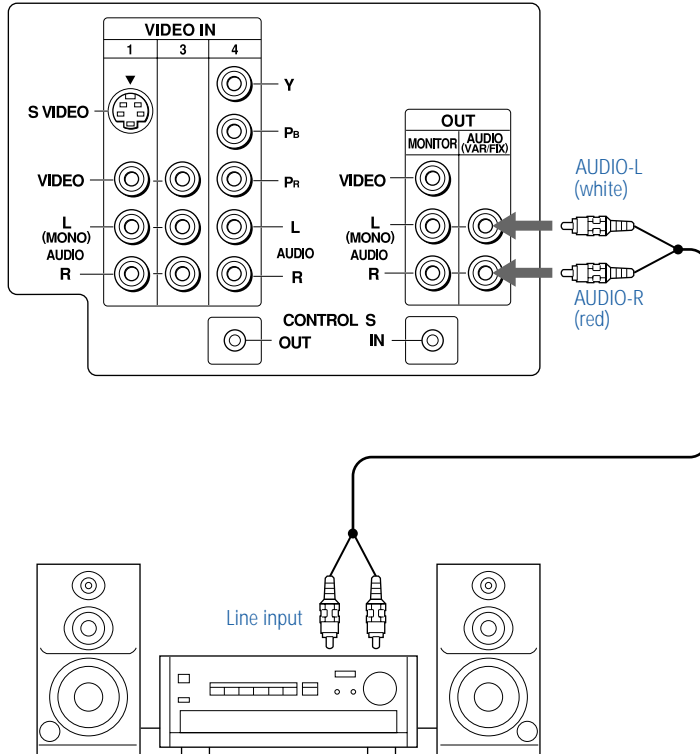

Connecting a DVD Player with Component Video Connectors

This is the preferred hookup to use if your DVD player has component video (Y, P_B, P_R) jacks.

- 1 Using three separate component video cables, connect the DVD player's Y, P_B and P_R jacks to the Y, P_B and P_R jacks on the TV. Use the VIDEO 4 connections.

 The Y, P_B and P_R jacks on your DVD player are sometimes labeled Y, C_B and C_R, or Y, B-Y and R-Y. If so, connect the cables to like colors.

- 2 Using an audio cable, connect the DVD player's Audio OUT jacks to the TV's Audio IN jacks. Be sure to use the same column (VIDEO 4) of inputs that you used for the video connection.

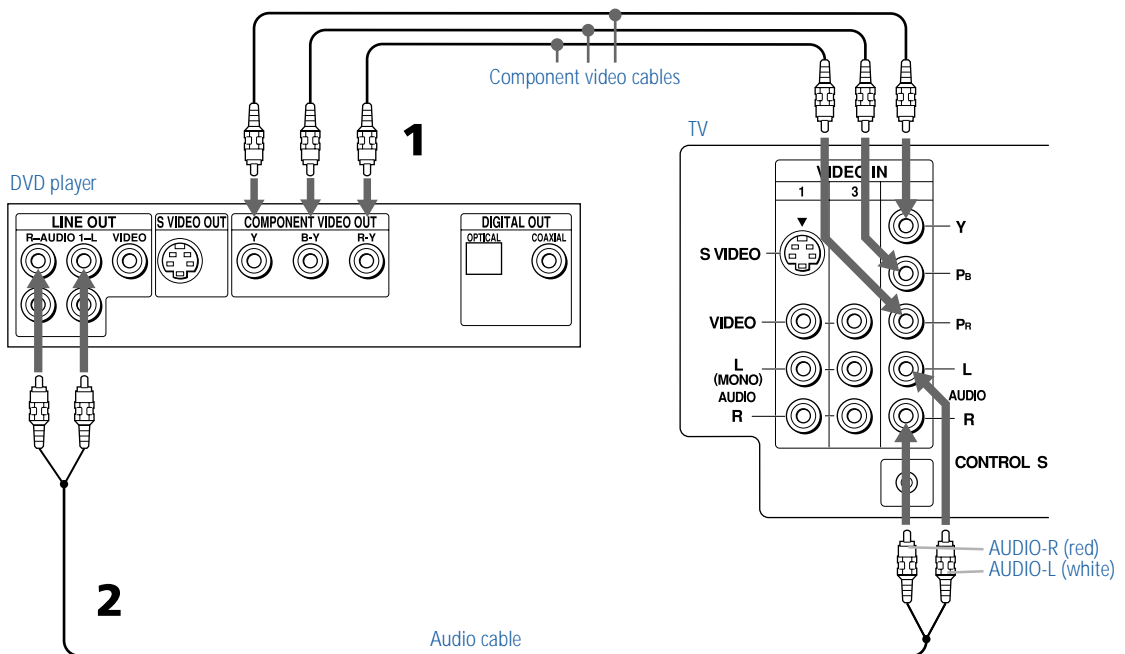

 You cannot record the signal from any equipment connected into the Y, P_B, P_R jacks.

Connecting a DVD Player with A/V Connectors

Use this hookup if your DVD player does not have component video (Y, Pb, Pr) jacks.

 An S VIDEO connection will give a good quality video signal, but if your DVD player has component video, that connection (described on the previous page) will give an even better video signal.

- 1 Using audio cables, connect the DVD player's Audio OUT jacks to the TV's Audio IN jacks.
- 2 Using an S VIDEO cable, connect the DVD player's S VIDEO jack to the TV's S VIDEO jack.

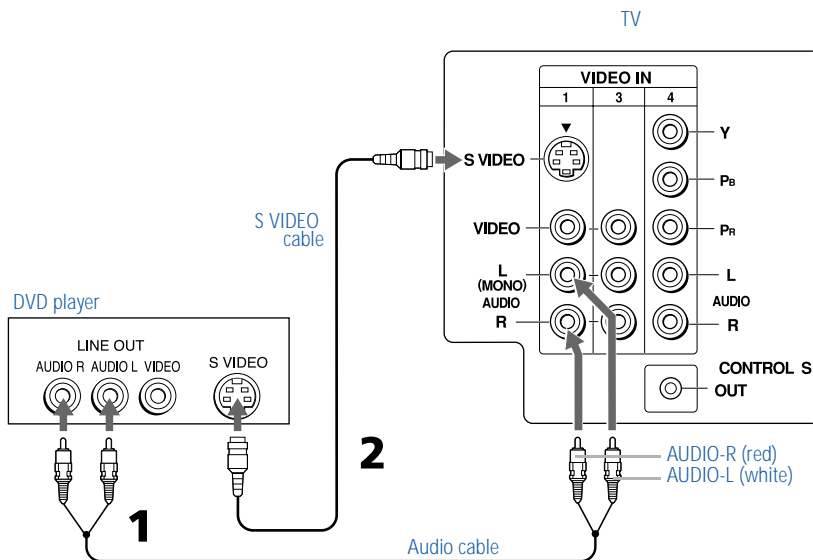

To switch between your TV and DVD

- Use the TV/VIDEO button on the remote control to switch from one input device to another.

Connecting a Camcorder

For easy connection of a camcorder, the TV has front Audio and Video inputs (shown below). If you prefer, however, you can connect the camcorder to the TV's rear Audio and Video IN jacks.

- 1 Using A/V cables, connect the camcorder's Audio and Video OUT jacks to the TV's Audio and Video IN jacks.

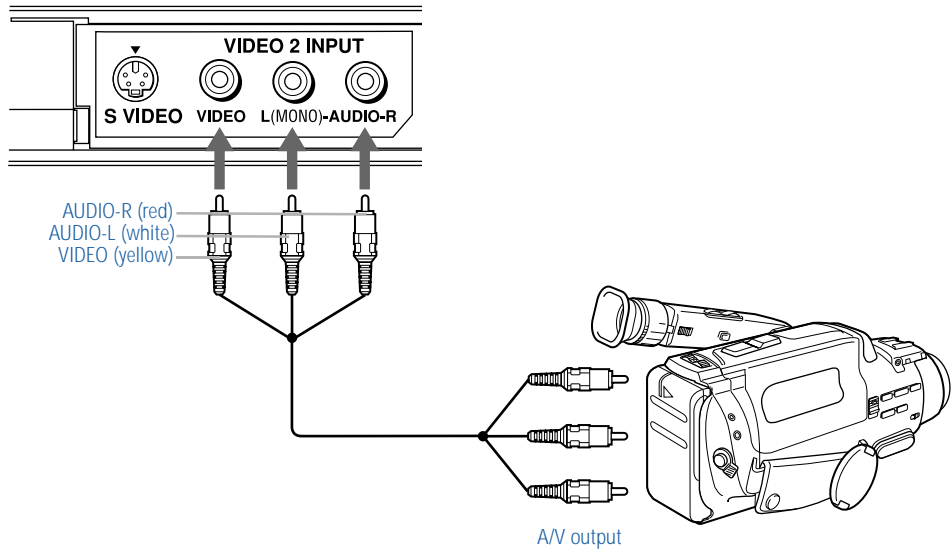

If you have a mono camcorder, connect its audio output to the TV's AUDIO L jack.

 If the camcorder has an S VIDEO jack, you can use an S VIDEO cable to improve picture quality; replace the yellow video cable of the combination A/V cable with the S VIDEO cable. You will still need audio cables for sound.

To view the camera's output

- Use the TV's remote control to set the appropriate input on the TV (VIDEO 2, in the illustration).

Using the CONTROL S Feature

The CONTROL S feature allows you to control other equipment through your TV. Pointing the remote control at your TV, rather than at the equipment, allows you to keep other equipment hidden or out of direct line of sight.

To control your other Sony equipment with your TV's remote control, use a CONTROL S cable (not supplied) to connect the equipment's CONTROL S IN jack to the TV's CONTROL S OUT jack.

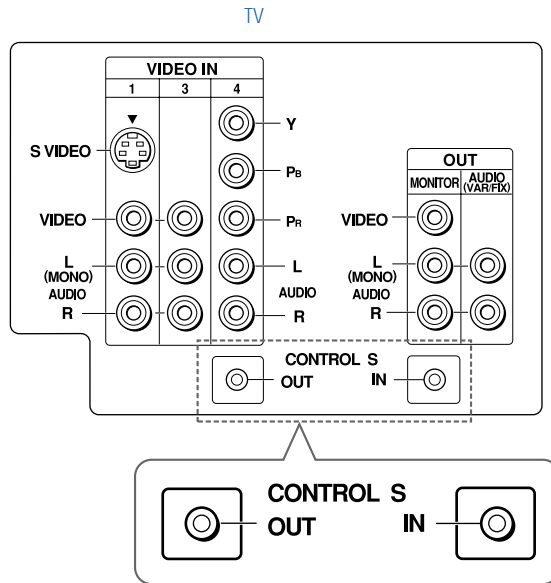

Setting Up the TV Automatically

After you finish connecting your TV, you need to run Auto Setup to set up your channels. The Auto Setup screen appears when you turn your TV on for the first time after installing it. If you do not want to set up the channels at this time, you can do it later by using the Auto Program feature in the Channel menu (see pages 42 and 43).



The Auto Setup feature does not apply for installations that use a cable box for all channel selection.

Using Auto Setup

- 1 Press **POWER** to turn on the TV.
- 2 Press the **TV** function button on the remote control.
- 3 Press **CH+** on the front of your TV to run the Auto Setup or press **CH-** to exit. If you use the channel buttons on your remote control, be sure to use the main set of buttons.

To reset TV to factory settings

- 1 Turn the TV on.
- 2 Hold down the **RESET** button on the remote control.
- 3 Press and release the **POWER** button on the TV. (The TV will turn itself off, then back on.)
- 4 Release the **RESET** button.

Using the Features

Overview

This chapter describes how to use special features of your TV.

<i>Topic</i>	<i>Page</i>
Using Favorite Channels	30
Using Picture in Picture (PIP)	31
Using Wireless Headphones	34

Using Favorite Channels

The Favorite Channel feature lets you select programs from a list of favorite channels that you specify.

To display a list of your favorite channels

- 1 If you have not already done so, create a list of favorite channels. (See the Favorite Channels section of “Selecting Channel Options” on page 42.)
- 2 If any menus are open, close them.
- 3 Press ⊕. (The Favorite Channels options appear.)



- 4 Press ▲ or ▼ to highlight the channel you want to watch. The program on that channel appears in the preview window. Press ⊕ to select.

Using Picture in Picture (PIP)

Picture in Picture (PIP) allows you to watch two channels simultaneously — one in the main window and another in a secondary (PIP) window.

Displaying Picture in Picture

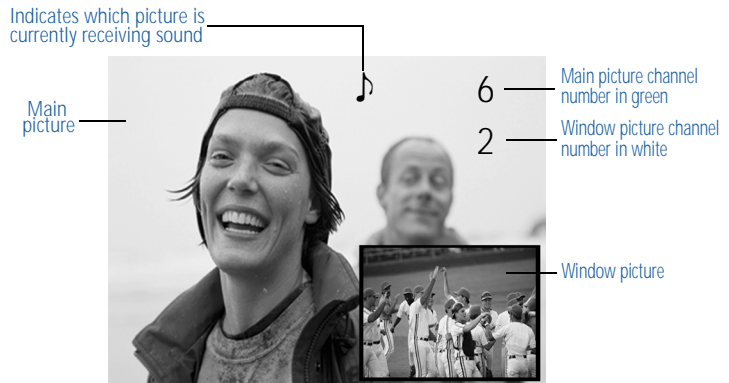

To use PIP:

- 1 Make sure your TV is tuned to a channel that you know is airing programming.
- 2 Press the  button (or the button labeled PIP). The window picture appears.
- 3 Use the yellow-labeled buttons on your remote control (see diagram) to control the PIP features (which are listed on the next page).

To check your PIP:

- 1 Tune your TV to a channel that you know is airing programming.
- 2 Press SWAP and select that same channel as the main window. You should now have the same program playing in both your main window and your picture window.
- 3 Use the PIP (yellow) CH+/- buttons to change the channel in the picture window.

 You must press TV (FUNCTION) before you can control PIP with the yellow-labeled buttons.

The AUX input cannot be viewed in the PIP window.

- 4 Now use the main CH+/- buttons of your remote control to change the channel in the main window. If this does not work, check “Troubleshooting” on page 56 for potential solutions.

PIP Functions

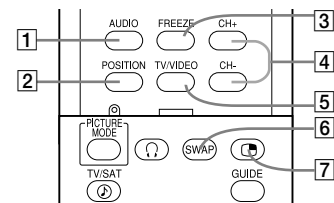

RM-Y182

<i>Yellow-labeled PIP Button</i>	<i>Description</i>
1 AUDIO	Alternates sound between the main picture and the window picture. The sound symbol (🔊) appears for 3 seconds, indicating whether you are hearing sound from the main picture or the window picture.
2 POSITION	Moves the location of the window picture among the four corners of the screen.
3 FREEZE	Freezes the window picture. Press again to restore the picture. The main window continues to play as usual.
4 CH +/-	Changes the channel in the window picture. To change the channel in the main window, use the main CH+/- buttons at the bottom of the remote control.
5 TV/VIDEO	Cycles through available video equipment you have connected to the TV.
6 SWAP	Switches the main picture with the window picture. Press again to change them back.
7 	Turns the PIP feature on and off. Press repeatedly to change the window size (1/9, 1/16, OFF).

To change channels/programs in the PIP window

- ❑ Use the yellow PIP CH+/- button to scroll through the TV channels.
- ❑ Use the yellow TV/VIDEO button to cycle through your other video equipment connected to the TV, such as your VCR, DVD player or Satellite Receiver.

Setups that affect your ability to use PIP

- ❑ Any video equipment you have connected to the AUX input cannot be viewed in the PIP window.
- ❑ If you are viewing all channels through a cable box, the PIP feature will not work. The cable box only unscrambles one signal at a time, so the window picture will be the same as the main picture.
- ❑ You can use PIP to see pictures from different sources on your TV. For example, you can have a regular (CATV) channel and the output from a VCR or DVD player or satellite receiver on screen at the same time using PIP. To do this:
 - 1 Connect the CATV cable to the UHF/VHF input on the back of the TV.
 - 2 Connect the peripheral (VCR or DVD player or satellite receiver) to any of the VIDEO IN inputs on the the back of the TV.
 - 3 Tune to one image in the main picture.
 - 4 Tune to a second image in the PIP window.

You can then SWAP the images on the TV screen.



Be sure to label your video sources to make them easier to find in the Display. See “Video Label” on page 49 for labeling instructions.



You cannot use a signal from the AUX connection with PIP.

Using Wireless Headphones

 Wireless headphones are included and can be used only with Sony TV models KV-32FV27 and 36FV27.

Installing the Battery

Install the supplied size AA (R6) battery into the headphones.

- 1 Open the battery compartment lid by pressing and sliding the lid as illustrated.

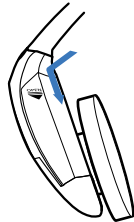

- 2 Insert the battery into the compartment with the positive side up and then close the lid.

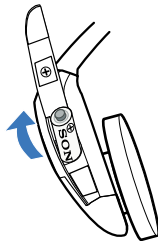



When used continuously, the battery lasts:

up to 40 hours	with an alkaline battery
up to 20 hours	with a manganese battery

Replace the battery with a new one when the sound becomes weak.

Using the Headphones

- 1 Press . (The  icon and channel number display.)



- 2 Turn on the power by placing the headphones securely onto your head.

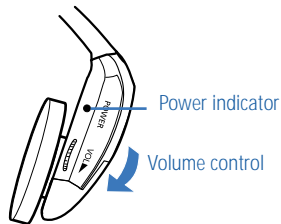

To listen to sound only from wireless headphones

- ❑ Turn down the TV speaker level, or press MUTING on the remote control.

To turn off headphones,

- ❑ Put down the headphones and press .

To ensure optimal sound reception with headphones

- ❑ Be sure that the infrared transmitter on the TV and the infrared sensors on the headphones have a clear (unobstructed) line of sight to one another.

To protect the TV's infrared transmitter from possible damage

- ❑ Press  to turn off the headphone feature when the headphones are not in use.

To protect your hearing from sudden or prolonged excessive volume

- ❑ Set the headphone volume just high enough to hear comfortably.

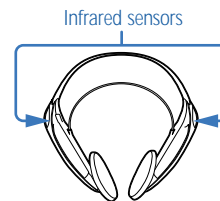
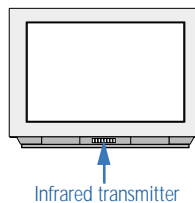

 For optimal sound quality, be sure that the infrared transmitter on the TV, and the infrared sensors on the headphones, are not obstructed and can "see" one another.



Listening to Sound from PIP Main and Window Pictures

To use your headphones to listen to the sound from the main or window picture (when using PIP), select the audio source.

- 1 If PIP is not already started, press  to display a PIP window.





- 2 Press .

The  icon and channel number appear for about three seconds. (The  is level with the channel number of the main picture.)



Main picture audio

Press  again to switch the audio to the PIP window. (The  changes - drops down - to the level of the PIP channel.)

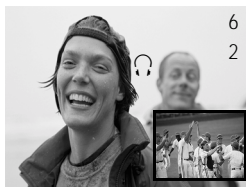

Window picture audio

- 3 When you are finished using the headphones, press  to turn them off.



Headphones off



Exiting from PIP returns the sound to the main picture.

The audio to the headphones automatically turns off when the TV is powered off.

SAP (Second Audio Programs) are not available in the PIP window.

Using the Menus

Overview

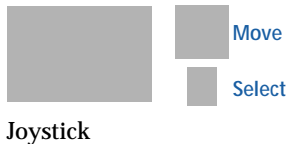







Joystick

Opening and choosing a menu:

- 1 Press MENU to display the Menu screen.
- 2 Use the joystick to move to the desired menu icon. Press ⊕ to select it.
- 3 Use the joystick to scroll up and down through the features.
- 4 See the specific menu page for instructions on moving through the menu.

The Menu gives you access to the following features:

<i>Menu Icon</i>	<i>Description</i>	<i>Page</i>
	Allows you to make adjustments to your picture settings. It also allows you to customize the Picture Mode based on the type of program you are viewing.	38
	Offers enhanced audio options such as listening to second audio programming (SAP) or customizing the Effect of the sound on your TV.	40
	Allows you to set up a Favorite Channel list, run the Auto Program function, and more.	42
	Lets you control the viewing of programs based on their ratings.	44
	Lets you set the clock on your TV and allows you to program your TV for scheduled viewing using the Timers.	47
	Provides several options for setting up your channels, labeling your video inputs, and selecting the language of the on-screen menus.	48
	Provides quick access to frequently used settings.	50

To end a menu session:

Press MENU again

To end one menu session and move to another:

Press ⇧ to return to the menu icons.

Move the joystick to choose a menu icon and press ⊕ to select it.



Using the Video Menu

To select the Video Menu

- 1 Press MENU.
- 2 Use the joystick to move to the Video icon  and press \oplus .
- 3 Use the joystick to scroll up and down through the options.
- 4 Press \oplus to select a feature. That feature's adjustment appears.
- 5 Use the joystick to make the desired adjustments.
- 6 Press \oplus to select/set.
- 7 Press MENU to exit the menu screen.



To restore the factory default settings for Picture, Brightness, Color, Hue, Sharpness, Color Temp and VM.

- Press RESET on the remote control when in the Video menu.

Selecting Video Options

 To change from one Video Mode to another, use the PICTURE MODE button on the remote control.

The Video Menu includes the following options.

Option	Description
Mode	Vivid Select for enhanced picture contrast and sharpness.
<i>Customized picture viewing</i>	Standard Select for standard picture settings.
	Movie Select to display a softer picture.
	Sports Select to display a brighter, more intense picture.
	 You can alter the Video Menu settings (Picture, Brightness, Color, etc.) for each Mode.
Picture	Adjust to increase picture contrast and deepen the color, or decrease picture contrast and soften the color.
Brightness	Adjust to brighten or darken the picture.
Color	Adjust to increase or decrease color intensity.
Hue	Adjust to increase or decrease the green tones.
Sharpness	Adjust to sharpen or soften the picture.

<i>Option</i>	<i>Description</i>
Color Temp	Choose from three color temperatures:
<i>White</i>	Cool Select to give the white colors a blue tint.
<i>intensity</i>	Neutral Select to give the white colors a neutral tint.
<i>adjustment</i>	Warm Select to give the white colors a red tint (NTSC-Standard).
VM	Sharpens picture definition to give every object a sharp, clean edge. Select from High, Low, OFF.
<i>Velocity</i>	
<i>Modulation</i>	



Using the Audio Menu

To select the Audio Menu

- 1 Press MENU.
- 2 Use the joystick to move to the Audio icon  and press \oplus .
- 3 Use the joystick to scroll up and down through the options.
- 4 Press \oplus to select an option. That option's settings appear.
- 5 Use the joystick to scroll through the settings.
- 6 Press \oplus to select the desired setting.
- 7 Press MENU to exit the menu screen.



 The TV set has a Standby/Stereo LED. The LED flashes when the set is first turned on. It glows steadily when:

- The TV is standing by for a command (no picture on screen);
- A program has stereo sound

To restore the factory default settings for Treble, Bass, and Balance

- Press RESET on the remote control when in the Audio menu.

Selecting Audio Options

 As a shortcut to using the menus, use the D button on the remote control to access the Steady Sound function.

The Audio Menu includes the following options:

<i>Option</i>	<i>Description</i>
Treble	Adjust to decrease or increase higher-pitched sounds.
Bass	Adjust to decrease or increase lower-pitched sounds.
Balance	Adjust to emphasize left or right speaker balance.
Steady Sound	ON Select to stabilize the volume.
	OFF Select to turn off Steady Sound.
Effect	Simulated Adds a surround-like effect to mono programs.
	SRS Produces a dynamic three-dimensional sound for stereo signals.
	OFF Normal stereo or mono reception.

<i>Option</i>	<i>Description</i>	
<i>MTS Enjoy stereo, bilingual and mono programs</i>	Stereo	Select for stereo reception when viewing a program broadcast in stereo.
	Auto-SAP	Select to automatically switch the TV to second audio programs when a signal is received. (If no SAP signal is present, the TV remains in Stereo mode.)
	Mono	Select for mono reception. (Use to reduce noise during weak stereo broadcasts.)
Speaker	ON	Select to turn on the TV speakers.
	OFF	Select to turn off the TV speakers and listen to the TV's sound only through your external audio system speakers.
<i>Audio Out Easy control of volume adjustments</i>	This option can be set only when the Speaker option is set to OFF.	
	Variable	The TV's speakers are turned off, but the volume output from your audio system can still be controlled by the TV's remote control.
	Fixed	The TV's speakers are turned off and the volume output of the TV is fixed. Use your audio receiver's remote control to adjust the volume through your audio system.



Using the Channel Menu

To select the Channel Menu

- 1 Press MENU.
- 2 Use the joystick to move to the Channel icon  and press \oplus .
- 3 Use the joystick to scroll up and down through the options.
- 4 Press \oplus to select a feature. That feature's options appear.
- 5 Use the joystick to scroll through the options.
- 6 Press \oplus to select the desired option.
- 7 Press MENU to exit the menu screen.



Selecting Channel Options

The Channel Menu includes the following options:

Option	Description
Favorite Channel	<ol style="list-style-type: none"> 1 Press \oplus to select a favorite channel number. 2 Use the joystick to scroll through the channels until you find the channel you want to add to your favorites. 3 Press \oplus to select it.
Cable	<p>ON Select if you are receiving cable channels with a CATV cable.</p> <p>OFF Select if you are using an antenna.</p> <p> You should run Auto Program after changing the cable setting.</p>
Channel Fix	<p>2-6 "Fix" your TV's channel setting to 2 – 6 and use the cable box or Satellite receiver to change channels. Select one of these settings if you have connected the device to the VHF/UHF jack.</p> <p>AUX 2-6 Same as 2 – 6, except you select one of these settings if you have connected the device to the AUX jack (see page 8).</p> <p>VIDEO 1 Use this setting if you have connected the device to the Audio and Video IN jacks.</p>
Auto Program	Automatically programs the TV for all receivable channels.

 Channels that you set to be skipped can be accessed only with the 0-9 buttons.

<i>Option</i>	<i>Description</i>
Channel Skip/Add	Removes and adds viewable channels. <ol style="list-style-type: none"> 1 Use the joystick to scroll through the channels until you find the channel you want to skip/add. 2 Press ⊕ to select it. 3 Press the joystick to toggle between “Add” or “Skip.” 4 Press ⊕ to select.
Channel Label	Label up to 40 channels with their station call letters.



Using the Parent Menu

The Parent menu allows you to set up the TV to block programs according to their content and rating levels.

To select the Parent Menu

- 1 Press MENU.
- 2 Use the joystick to move to the Parent icon  and press \oplus .
- 3 Use the 0-9 buttons on the remote control to enter your four-digit password.
- 4 Confirm your password by entering it again. (The Parent menu options appear.)
- 5 Use the joystick to scroll through the settings.
- 6 Press \oplus to select the desired setting.
- 7 Press MENU to exit the menu screen.



 You need your password for any future access into the Parent menu. If you lose your password, see "Lost password" on page 57.

Using the Parent Menu

 If you are not familiar with the Parental Guideline rating system, you should select Child, Youth, or Young Adult to help simplify the rating selection. To set more restrictive ratings, select Custom.

 For descriptions of Child, Youth, and Young Adult ratings, see page 45.

The Parent menu includes the following options.

Option	Description
Parental Lock	OFF Parental lock is off. No programs are blocked from viewing.
<i>Turn ratings on/off and select a rating system</i>	Child Maximum ratings permitted are: <input type="checkbox"/> US: TV-Y, TV-G, G <input type="checkbox"/> Canada: C, G
	Youth Maximum ratings permitted are: <input type="checkbox"/> US: TV-PG, PG <input type="checkbox"/> Canada: 8 ans+
	Young Adult Maximum ratings permitted are: <input type="checkbox"/> US: TV-14, PG-13 <input type="checkbox"/> Canada: 14+, 13 ans+
	Custom Select to set ratings manually. <input type="checkbox"/> US: See page 45 for details. <input type="checkbox"/> Canada: See page 46 for details.
Change Password	For changing your password.

US Models: Selecting Custom Rating Options

 The content ratings will increase depending on the level of the age-based rating. For example, a program with a TV-PG V (Violence) rating may contain moderate violence, while a TV-14 V (Violence) rating may contain more intense violence.

 To ensure maximum blocking capability, the age-based ratings should be blocked.

 If you block unrated TV programs, be aware that the following types of programs may be blocked: emergency broadcasts, political programs, sports, news, public service announcements, religious programs and weather.

For US models, the Custom Rating Menu includes the following options. (For Canadian models, see page 46.)

<i>Option</i>	<i>Description</i>	
Movie Rating	G All children and General Audience.	
	PG Parental Guidance suggested.	
	PG-13 Parental Guidance for children under 13.	
	R Restricted viewing, parental guidance is suggested for children under 17.	
	NC-17 and X No one 17 or under allowed.	
TV Rating	Age-Based Options	
<i>Block programs by their rating, content or both</i>	TV-Y All children.	
	TV-Y7 Directed to older children.	
	TV-G General Audience.	
	TV-PG Parental Guidance suggested.	
	TV-14 Parents Strongly cautioned.	
	TV-MA Mature Audience only.	
	Content-Based Options	
	FV Fantasy Violence.	
	D Suggestive Dialogue.	
	L Strong Language.	
S Sexual situations.		
V Violence.		
Unrated	Block Blocks all programs and movies that are broadcast without a rating.	
	<i>Block programs or movies that are broadcast without a rating</i>	
	Allow Allows programs and movies that are broadcast without a rating.	

Viewing Blocked Programs

You can view blocked programs by entering the password. Press the ENTER button when tuned to a blocked program, then enter the password. This temporarily switches off the Parental Lock. To reactivate the Parental Lock settings, turn off the TV. When the TV is turned on again, your Parental Controls settings are reactivated.

*Canadian Models:
Selecting Custom
Rating Options*

For Canadian models, the Custom Rating Menu includes the following options. (For US models, see page 45.)

<i>Option</i>	<i>Description</i>	
English Rating	C	All children.
	C8	Children 8 years and older.
	G	General programming.
	PG	Parental Guidance.
	14+	Viewers 14 and older.
	18+	Adult programming.
French Rating	G	General programming.
	8 ans+	Not recommended for young children.
	13 ans+	Not recommended for ages under 13.
	16 ans+	Not recommended for ages under 16.
	18 ans+	Programming restricted to adults.
USA Rating	See "US Models" on page 45 for details.	

*Viewing Blocked
Programs*

You can view blocked programs by entering the password. Press the ENTER button when tuned to a blocked program, then enter the password. This temporarily switches off the Parental Lock. To reactivate the Parental Lock settings, turn off the TV. When the TV is turned on again, your Parental Controls settings are reactivated.



Using the Timer Menu

To select the Timer Menu

- 1 Press MENU.
- 2 Use the joystick to move to the Timer icon  and press \oplus .

To set the Current Time

- 1 Use the joystick to select “Current Time”, then press \oplus .
- 2 If your location is currently in Daylight Saving Time, be sure to set the mode to “ON”. (Daylight Saving Time starts in the Spring, and ends in the Fall.)
- 3 Use the joystick to enter the correct time, then press \oplus .
- 4 Press MENU to exit the menu screen.



To set the Timer

Before setting the timer, be sure to set your TV's clock to the current time (and, if appropriate, to Daylight Saving mode).

- 1 Use the joystick to move to “Timer 1” or “Timer 2”, then press \oplus .
- 2 Use the joystick to enter your date, time and channel preferences, then press \oplus to select each one.
- 3 Press MENU to exit the menu screen. An LED on the front panel will light, indicating the timer has been set.

To reset the Clock or Timers

- Press RESET on the remote control, when in the Timer menu, to reset to the factory defaults.

Selecting Timer Options

The Timer Menu includes the following options:

Option	Description
Timer 1	Program
Timer 2	OFF
Current Time	Set the current time.
Daylight Saving	ON
	OFF



Using the Setup Menu

To select the Setup Menu

- 1 Press MENU.
- 2 Use the joystick to move to the Setup icon  and press \oplus .
- 3 Use the joystick to scroll through the features.
- 4 Press \oplus to select a feature. (That feature's options appear.)
- 5 Use the joystick to scroll through the options.
- 6 Press \oplus to select the desired option.
- 7 Press MENU to exit the menu screen.



Selecting Setup Options

The Setup Menu includes the following options:

<i>Option</i>	<i>Description</i>
Caption Vision	Allows you to select from three closed-caption modes (for programs that are broadcast with closed caption).
CC1, CC2, CC3, CC4	Displays a printed version of the dialog or sound effects of a program. (Should be set to CC1 for most programs.)
TEXT1, TEXT2, TEXT3, TEXT4	Displays network/station information presented using either half or the whole screen (if available). For closed captioning, set to CC1.
XDS (Extended Data Service)	Displays a network name, program name, program length, and time of the show (if the broadcaster offers this service).
OFF	Turns off Caption Vision.

<i>Option</i>	<i>Description</i>
Video Label	Allows you to label the audio/video components you connected to the TV, so you can identify them when using the TV/VIDEO button. When in the Setup menu's Video Label feature, use the joystick to highlight an input to label, then press \oplus to select it. Use the joystick to scroll through the labels. Press \oplus to select the component you connected to each of the input jacks on the back of your TV. Select "Skip" if you do not have a component connected to a particular set of input jacks.
VIDEO 1/2/3	Choose VHS, 8mm, Beta, LD, Game, SAT, DVD, Web, Receiver, DTV, Skip
VIDEO 4	Choose DVD, DTV, Skip
	 If you select "Skip", your TV skips this connection when you press the TV/VIDEO button.
Tilt Correction	Allows you to correct any tilt of the picture.
Language	Select to display all on-screen menus in your language of choice.
16:9 Enhanced	Provides enhanced picture resolution for widescreen (anamorphic) sources, such as selected DVD titles (only available when the TV is in VIDEO mode). Press TV/VIDEO and select from one of the following options:
	ON To activate.
	OFF To turn off 16:9.
Demo	Runs a demonstration of on-screen menus.

 To use this feature with widescreen DVDs, set your DVD player to 16:9 aspect ratio.



Using the Basic Menu

To select the Basic Menu

- 1 Press MENU.
- 2 Use the joystick to move to the Basic icon  and press \oplus .
- 3 Use the joystick to scroll through the features.
- 4 Press \oplus to select a feature. (That feature's options appear.)
- 5 Use the joystick to scroll through the options.
- 6 Press \oplus to select the desired option.
- 7 Press MENU to exit the menu screen.



Selecting Basic Options

 As a shortcut to using the menu, use the D button on the remote control to access Steady Sound option.

The Basic Menu includes the following options:

<i>Option</i>	<i>Description</i>
Picture	Adjust the picture contrast.
Caption Vision	Displays your current advanced-menu setting: (CC1-4, TEXT 1-4, or XDS) and OFF.
Effect	Simulated Adds a surround-like effect to mono programs.
	SRS Produces a dynamic three-dimensional sound for stereo signals.
	OFF Normal stereo or mono reception.
Advanced Menu	Select to return to the advanced menus.

Other Information

Overview

This chapter includes the following topics:

<i>Topic</i>	<i>Page</i>
Programming the Remote Control	52
Operating Other Components with Your TV Remote Control	54
Troubleshooting	56
Specifications	58
Index	61

Programming the Remote Control

The remote control is preset to operate Sony-brand video equipment.

<i>Sony Equipment</i>	<i>Switch Position on Remote Control</i>	<i>Programmable Code Number</i>
Beta, ED Beta VCRs	AV1	303
8 mm VCR	AV2	302
VHS VCR	AV3	301
DVD Player	DVD	751

If you have video equipment other than Sony brand that you want to control with the TV's remote control, use the following procedure to program the remote control.

 The equipment must have infrared (IR) remote capability in order to be used with the remote control.



- ❑ If more than one code number is listed, try entering them one by one until you come to the correct code for your component.
- ❑ If you enter a new code number, the code number you previously entered at that setting is erased.
- ❑ In some cases, you may not be able to operate your component with the supplied remote control. In such cases, use the component's own remote control unit.
- ❑ Whenever you remove the batteries to replace them, the code numbers may revert to the factory setting and must be reset.

- 1 Check the list of "Manufacturer's Codes" on page 53, and find the three-digit code number for the manufacturer of your component. (If more than one code number is listed, use the number listed first.)

 You must do step 4 within 10 seconds of step 3, or you must redo steps 2 and 3.

- 2 Press CODE SET.
- 3 Press the function button for the type of component you want to control with the TV's remote control (VCR/DVD or SAT/CABLE).
- 4 Enter the three-digit manufacturer's code number.
- 5 Press ENTER.
- 6 To check if the code number works, aim the TV's remote control at the component and press the green POWER button that corresponds with that component. If it responds, you are done. If not, try using another code listed for that manufacturer.

Manufacturer's Codes

VCRs

<i>Manufacturer</i>	<i>Code</i>
Sony	301, 302, 303
Admiral (M. Ward)	327
Aiwa	338, 344
Audio Dynamic	314, 337
Broksonic	319, 317
Canon	309, 308
Citizen	332
Craig	302, 332
Criterion	315
Curtis Mathes	304, 338, 309
Daewoo	341, 312, 309
DBX	314, 336, 337
Dimensia	304
Emerson	319, 320, 316, 317, 318, 341
Fisher	330, 335
Funai	338
General Electric	329, 304, 309
Go Video	322, 339, 340
Goldstar	332
Hitachi	306, 304, 305, 338
Instant Replay	309, 308
JC Penney	309, 305, 304, 330, 314, 336, 337
JVC	314, 336, 337, 345, 346, 347
Kenwood	314, 336, 332, 337
LXI (Sears)	332, 305, 330, 335, 338
Magnavox	308, 309, 310
Marantz	314, 336, 337
Marta	332
Memorex	309, 335
Minolta	305, 304
Mitsubishi/ MGA	323, 324, 325, 326
Multitech	325, 338, 321
NEC	314, 336, 337

<i>Manufacturer</i>	<i>Code</i>
Olympic	309, 308
Optimus	327
Panasonic	308, 309, 306, 307
Pentax	305, 304
Philco	308, 309
Philips	308, 309, 310
Pioneer	308
Quasar	308, 309, 306
RCA/ PROSCAN	304, 305, 308, 309, 311, 312, 313, 310, 329
Realistic	309, 330, 328, 335, 324, 338
Sansui	314
Samsung	322, 313, 321
Sanyo	330, 335
Scott	312, 313, 321, 335, 323, 324, 325, 326
Sharp	327, 328
Shintom	315
Signature 2000 (M. Ward)	338, 327
SV2000	338
Sylvania	308, 309, 338, 310
Symphonic	338
Tashiro	332
Tatung	314, 336, 337
Teac	314, 336, 338, 337
Technics	309, 308
Toshiba	312, 311
Wards	327, 328, 335, 331, 332
Yamaha	314, 330, 336, 337
Zenith	331

Laserdisc Players

<i>Manufacturer</i>	<i>Code</i>
Sony	701
Panasonic	704, 710
Pioneer	702

DVD Players

<i>Manufacturer</i>	<i>Code</i>
Sony	751
Hitachi	758
JVC	756
Magnavox	757
Mitsubishi	761
Oritron	759
Panasonic	753
Philips	757
Pioneer	752
RCA	755
Samsung	758
Toshiba	754
Zenith	760

Cable Boxes

<i>Manufacturer</i>	<i>Code</i>
Sony	230
Hamlin/Regal	222, 223, 224, 225, 226
Jerrold/G. I.	201, 202, 203, 204, 205, 206, 207, 208, 218
Oak	227, 228, 229
Panasonic	219, 220, 221
Pioneer	214, 215
Scientific Atlanta	209, 210, 211
Tocom	216, 217
Zenith	212, 213

Satellite Receivers

<i>Manufacturer</i>	<i>Code</i>
Sony	801
Dish Network	810
Echostar	810
General Electric	802
Hitachi	805
Hughes	804
Mitsubishi	809
Panasonic	803
RCA/ PROSCAN	802, 808
Toshiba	806, 807

Operating Other Components with Your TV Remote Control

Operating a VCR

Move the slide switch to the AV input you coded for the VCR.

<i>To Do This ...</i>	<i>Press</i>
Turn on/off	VCR/DVD (green POWER button)
Select VCR	VCR/DVD (FUNCTION button)
Change channels	CH +/-
Record	● and □ simultaneously.
Play	▶
Stop	■
Fast forward	▶▶
Rewind the tape	◀◀
Pause	(press again to resume normal playback)
Search the picture forward or backward	▶▶ or ◀◀ during playback (release to resume normal playback)
Change input mode	TV/VCR

Operating a DVD Player

Move the slide switch to the AV input you coded for the DVD Player.

<i>To Do This ...</i>	<i>Press</i>
Turn on/off	VCR/DVD (green POWER button)
Select DVD	VCR/DVD (FUNCTION button)
Play	▶
Stop	■
Pause	(press again to resume normal playback)
Step through different tracks of an audio disc	▶▶ to step forward, or ◀◀ to step backward
Step through different chapters of a video disc	CH+ to step forward, or CH- to step backward
Select tracks directly	0-9 buttons
Display the menu (Setup)	MENU

Operating a Cable Box

<i>To Do This ...</i>	<i>Press</i>
Turn on/off	SAT/CABLE (green POWER button)
Select Cable Box	SAT/CABLE (FUNCTION button)
Select a channel	0-9 buttons, ENTER
Change channels	CH +/-
Back to previous channel	JUMP

Operating a Satellite Receiver

<i>To Do This ...</i>	<i>Press</i>
Turn on/off	SAT/CABLE (green POWER button)
Select Satellite Receiver	SAT/CABLE (FUNCTION button)
Select a channel	0-9 buttons, ENTER
Change channels	CH +/-
Back to previous channel	JUMP
Change input mode	TV/SAT
Display channel number	DISPLAY
Display DBS guide	GUIDE
Display DBS menu	MENU
Move highlight (cursor)	Joystick
Select item	↔ button

Operating an MDP (Laserdisc Player)

Move the slide switch to the AV input you coded for the selected switch position.

<i>To Do This ...</i>	<i>Press</i>
Turn on/off	VCR/DVD (green POWER button)
Select AV 1, 2, 3 or DVD switch position	VCR/DVD (FUNCTION button)
Play	▶
Stop	■
Pause	(press again to resume normal playback)
Search the picture forward or backward	▶▶ or ◀◀ during playback (release to resume normal playback)
Search a chapter forward or backward	CH +/-

Troubleshooting

<i>Problem</i>	<i>Possible Remedies</i>
Reset TV to factory settings	<ul style="list-style-type: none">❑ Turn on the TV. While holding down the RESET button on the remote control, press the POWER button on the TV. (The TV will turn itself off, then back on again.) Release the RESET button.
No picture (screen not lit), no sound	<ul style="list-style-type: none">❑ If your TV does not turn on, and a red light keeps flashing, your TV may need service. Call your local Sony Service Center.❑ Make sure the power cord is plugged in.❑ Push the power button on the front of the TV.❑ Check to see if the TV/VIDEO setting is correct: when watching TV, set to TV. When watching connected equipment, set to VIDEO 1, 2, 3, or 4, as appropriate.❑ Try another channel, it could be station trouble.
Remote control does not operate	<ul style="list-style-type: none">❑ Batteries could be weak. Replace the batteries.❑ Press TV (FUNCTION) when operating your TV.❑ Make sure the TV's power cord is connected securely to the wall outlet.❑ Locate the TV at least 3-4 feet away from fluorescent lights.❑ Check the orientation of the batteries.
Dark, poor or no picture (screen lit), good sound	<ul style="list-style-type: none">❑ Adjust the Picture setting in the Video menu (see page 38).❑ Adjust the Brightness setting in the Video menu (see page 38).❑ Check antenna/cable connections.
Good picture, no sound	<ul style="list-style-type: none">❑ Press MUTING so that "MUTING" disappears from the screen (see page 4).❑ Make sure Speaker is set to ON in the Audio menu (see page 40).
Cannot receive upper channels (UHF) when using an antenna	<ul style="list-style-type: none">❑ Change Cable to OFF (see page 42).❑ Use Auto Program in the Channel menu to add receivable channels that are not presently in the TV's memory (see page 42).
No color	<ul style="list-style-type: none">❑ Adjust the Color settings in the Video menu (see page 38).
Only snow and noise appear on the screen	<ul style="list-style-type: none">❑ Check the antenna/cable connections.❑ Try another channel; it could be station trouble.❑ Press ANT to change the input mode (see page 5).
Dotted lines or stripes	<ul style="list-style-type: none">❑ Adjust the antenna.❑ Move the TV away from noise sources such as cars, neon signs, or hair-dryers.
TV is fixed to one channel	<ul style="list-style-type: none">❑ Use Auto Program in the Channel menu to add receivable channels that are not presently in the TV's memory (see page 42).❑ Check your Channel Fix settings (see page 42).
Double images or ghosts	<ul style="list-style-type: none">❑ Using a highly directional outdoor antenna or a cable may solve the problem.
Cannot operate menu	<ul style="list-style-type: none">❑ If the item you want to choose appears in gray, you cannot select it.
Cannot receive any channels when using cable TV	<ul style="list-style-type: none">❑ Use Auto Program in the Channel menu to add receivable channels that are not presently in the TV's memory (see page 42).❑ Check your cable settings.❑ Make sure Cable is set to ON in the Channel menu (see page 42).

<i>Problem</i>	<i>Possible Remedies</i>
Cannot gain enough volume when using a cable box	<ul style="list-style-type: none"> <input type="checkbox"/> Increase the volume of the cable box using the cable box's remote control. Then press TV (FUNCTION) and adjust the TV's volume.
Cannot receive channels	<ul style="list-style-type: none"> <input type="checkbox"/> Use Auto Program in the Channel menu to add receivable TV channels that are not presently in TV memory (see page 42).
Unable to select a channel	<ul style="list-style-type: none"> <input type="checkbox"/> Use Auto Program in the Channel menu to add receivable TV channels that are not presently in TV memory (see page 42).
Lost password	<ul style="list-style-type: none"> <input type="checkbox"/> In the password screen (see page 44), enter the following master password: 4357. The master password clears your previous password; it cannot be used to temporarily unblock channels.
Cannot change channels with the remote control	<ul style="list-style-type: none"> <input type="checkbox"/> If you are using the TV to change channels, be sure the TV FUNCTION button is selected. <input type="checkbox"/> If you are using another device to change channels, be sure you have not inadvertently switched your TV from the channel 3 or 4 setting. Use the Channel Fix feature to "fix" the channel based on the hookup you used (see page 42). <input type="checkbox"/> If you are using another device to change channels, be sure to press the green "FUNCTION" button for that device. For example, if you are using your VCR to change channels, be sure to press the VCR/DVD FUNCTION button.
Cannot cycle through the other video equipment connected to the TV	<ul style="list-style-type: none"> <input type="checkbox"/> Be sure the Video Label feature has not been set to "Skip" (see page 49).
There is a black box on the screen	<ul style="list-style-type: none"> <input type="checkbox"/> You have selected a text option in the Setup menu and no text is available. (See page 48 to reset Setup selections.) To turn off this feature, select OFF in the Caption Vision option. If you were trying to select closed captioning, select CC1 instead of TEXT 1-4.
The remote control will not work in PIP mode	<ul style="list-style-type: none"> <input type="checkbox"/> Press the TV FUNCTION button. You may have inadvertently pressed the VCR/DVD FUNCTION button, which changes the PIP buttons to VCR mode.
There is no window picture or it is just static	<ul style="list-style-type: none"> <input type="checkbox"/> Be sure your window picture is set to a video source/channel that has a program airing. <input type="checkbox"/> You may be tuned to a video input with nothing connected to it. Try cycling through your video inputs using the PIP TV/VIDEO button. <input type="checkbox"/> PIP is not set to receive a signal from the AUX input. If you connected a VCR, DVD player or Satellite Receiver to the AUX input on the TV, it will not show in the small window picture.
I get the same program in the window picture as in the main picture	<ul style="list-style-type: none"> <input type="checkbox"/> Both may be set to the same channel. Try changing channels in either the main picture or the window picture. <input type="checkbox"/> You may using a cable box for all your channels. If you must have a cable box to unscramble all channels, then you are limited to only one picture (because that is all that the cable box allows - one channel at a time). But if you need the cable box only part time (to unscramble premium channels), then you can use PIP when you are not using the cable box (when you use the CATV cable without going through the box).
I cannot get anything but TV in my window picture	<ul style="list-style-type: none"> <input type="checkbox"/> Be sure the video label has not been set to skip your video inputs. (See the Setup menu on page 49.)

If, after reading these operating instructions, you have additional questions related to the use of your Sony television, please call our Direct Response Center at 1-800-222-SONY (7669) (U.S. residents only) or (416) 499-SONY (7669) (Canadian residents only).

Specifications

All Models (General)

Picture Tube	FD Trinitron® tube	
Antenna	75 ohm external terminal for VHF/UHF	
Television System	NTSC, American TV Standard	
Channel Coverage		
VHF	2-13	
UHF	14-69	
CATV	1-125	
Power Requirements	120V, 60 Hz	
Number of Inputs/Outputs		
Video (IN)	3	1 Vp-p, 75 ohms unbalanced, sync negative
S Video (IN)	2	Y: 1 Vp-p, 75 ohms unbalanced, sync negative C: 0.286 Vp-p (Burst signal), 75 ohms
Audio (IN)	4	500 mVrms (100% modulation) Impedance: 47 kilohm
Variable/Fixed Audio (OUT)	1	More than 408 mVrms at the maximum volume setting (Variable) More than 408 mVrms (Fixed) Impedance (output): 2 kilohms
Monitor Out	1	1 Audio/Video output (1 Vp-p, 75 ohms unbalanced, sync negative)
CONTROL-S (IN/OUT)	1	
Component Video Input	1 (Y, P _B , P _R)	Y: 1.0 Vp-p, 75 ohms unbalanced, sync negative; P _B : 0.7 Vp-p, 75 ohms P _R : 0.7 Vp-p, 75 ohms

KV-32FV27

Supplied Accessories		
Remote Control	RM-Y182	
AA (R6) Batteries	2 supplied for remote control, 1 supplied for wireless headphones	
Wireless Stereo Headphones	MDR-IF0230	
Optional Accessories		
AV Cable	VMC-810/820/830 HG	
Audio Cable	RKC-515HG	
Component Video Cable	VMC-10/30 HG	
TV Stand	SU-32FD4	
Visible Screen Size	32 in (812.8 mm) picture measured diagonally	
Actual CRT Size	34 in (863.6 mm) picture measured diagonally	
Speaker Output	15 W x 2	
Dimensions (W x H x D)	882 x 687 x 592 mm (34 3/4 x 27 x 23 1/4 in)	
Mass	80 kg (176 lbs)	
Power Consumption		
In Use	210 W	
In Standby	2 W	

KV-36FV27**Supplied Accessories**

Remote Control	RM-Y182
AA (R6) Batteries	2 supplied for remote control, 1 supplied for wireless headphones
Wireless Stereo Headphones	MDR-IF0230

Optional Accessories

AV Cable	VMC-810/820/830 HG
Audio Cable	RKC-515HG
Component Video Cable	VMC-10/30 HG
TV Stand	SU-36FD4

Visible Screen Size	36 in (914.4 mm) picture measured diagonally
---------------------	--

Actual CRT Size	38 in (965.2 mm) picture measured diagonally
-----------------	--

Speaker Output	15 W x 2
----------------	----------

Dimensions (W x H x D)	975 x 757 x 633 mm (38 3/8 x 29 3/4 x 24 7/8 in)
------------------------	--

Mass	107 kg (236 lbs)
------	------------------

Power Consumption

In Use	210 W
In Standby	2 W

Index

16:9 (widescreen) 2, 49

A

Activating a PIP screen 31
Adding channels to the channel list 42, 43
Adjusting the picture definition 39
Adjusting the audio 40, 50
ANT button 5
Aspect ratio, 16:9 49
Audio menu 37, 40
audio receiver, connecting 22
Auto Program (channel setup) 27, 42
Auto-SAP 41
Auto setup 27

B

balance, adjusting 40
Basic menu 37, 50
bass, adjusting 40
batteries
 inserting in remote 3
 inserting in wireless headphones 34
bilingual audio 41
blocking programs. See ratings.
brightness, adjusting 38

C

cable
 box, connecting with VCR 15
 connecting 10-13
 setting ON/OFF 42
 with VCR, connecting 14
cable box, using with TV remote control 55
camcorder, connecting 25
Caption Vision 48, 50
CATV. see cable
Channel List
 Adding channels to 43
 Removing channels from 43
Channel menu 37, 42
Channel Setup menu 42

Channel Skip/Add 43
channels

 creating labels 43
 setting up 27

closed caption modes 48

Code Set Button 4, 52

color temperature, adjusting 39

color, adjusting 38

Connecting:

 Audio Receiver 22
 Cable or antenna 10-13
 Cable box 11-13
 Camcorder 25
 DVD player 23, 24
 Satellite receiver 19
 VCR 14-18
 VCR with satellite receiver 20

Contents of box 3

CONTROLS 26

Controls and connections 8

Converter 12

D

Demo, menus 49

Display

 button 4
 turning off 4

DVD player

 using with TV remote control 54
 with A/V connectors, connecting 24
 with component video connectors, connecting 23

E

Enhanced picture resolution 49

Extended Data Service 48

F

- Favorite Channel
 - setting up 42
 - using 30
- features 2
- Front Panel controls 8

G

- Guide button 5

H

- headphones, see wireless headphones
- Hookups 10-26
- hue, adjusting 38

I

- inputs, labeling 49

J

- Jump button 4

L

- label
 - channels 43
 - video inputs 49
- Languages, closed captioning menu 49
- LED
 - Standby/Stereo 40
 - Timer 47
- Locking programs 44

M

- Manufacturer's Codes 53
- MDP, using with TV remote control 55
- Menu button 4
- menus
 - Audio 37, 40
 - Basic 37, 50
 - Channel 37, 42
 - Channel Setup 42
 - Parent 37, 44
 - Parental Control 44
 - Setup 37, 48
 - Timer 37, 47
 - Video 37, 38
- MTS 5, 41
- Muting 4

P

- Parent menu 37, 44
- parental control, described 2
- password
 - changing 44
- picture contrast, adjusting 38
- picture definition, adjusting 39
- Picture in Picture (PIP), using 31
- picture, adjusting 50
- Picture Mode 4
- Picture size, adjusting in PIP 32
- power cord, removing from holder 7
- presetting channels 42
- problems, troubleshooting 56-57

R

- ratings, setting 44-45
- ratings, viewing blocked programs 45, 46
- Rear panel controls and connections 8-9
- remote control
 - described 4-5
 - inserting batteries 3
 - programming 52
- Remote control, buttons inside cover 5
- Remote control, operating other components
 - with
 - VCR 54
 - MDP 55
 - Satellite receiver 55
 - DVD 54
 - Cable box 55
- Removing channels from the channel list 42
- Reset button 5
- resetting
 - Audio options 40
 - Timer options 47
 - Video options 38

S

- SAT/CABLE power button 4
- SAT/CABLE function button 4
- satellite receiver, using with TV remote control
 - 55
- Setting favorite channels 42
- setting up channels 27, 42
- Setup menu 37, 48
- sharpness, adjusting 38

Simulated 40, 50
Sleep timer/button 4
sound effect (3-D), adjusting 40, 50
speakers
 turning on/off 41
 using external speakers 41
specifications 58-59
Standby/Stereo LED 40
Steady Sound
 adjusting 40
 described 2

T

tape-to-tape editing 18
tilt, correcting 49
Time
 set current 47
 set daylight saving 47
Timer
 LED 47
 menu 37, 47
Timer setting 47
treble, adjusting 40
troubleshooting 56-57
TV function button 4
TV power button 4
TV/VIDEO button 5

V

VCR
 connecting two, for tape editing 18
 using with TV remote control 54
 with cable box, connecting 15
 with cable, connecting 14
 with satellite receiver, connecting 20
VCR/DVD power button 4
VCR/DVD function button 4
Velocity Modulation 2, 39
video inputs, labeling 49
Video menu 37, 38
Video Modes, selecting 38

W

Wega, described 2
widescreen 49
widescreen, described 2
wireless headphones 34-36

